

Tavoli Incas

Tables, Tische, Tables, Mesas.

v. 17061 20181108/4 - TB

p. 1/7

design Angelo Mangiarotti, 1973

Tavoli in marmo o pietra

Marble or stone tables

AINC90240722 / AINC90280722

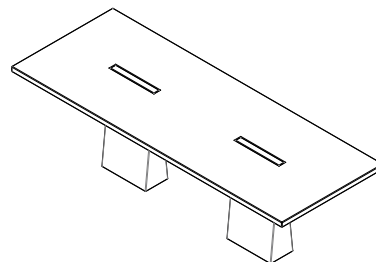

H. 72
(28" 11/32)

AINC90240722

240 (94" 31/64)



gamba/leg kg. 96

AINC90280722

280 (110" 15/64)



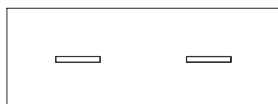

gamba/leg kg. 96

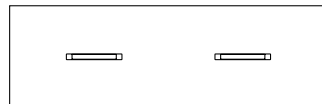

piano/top kg. 233  x8

90
(35" 7/16)



piano/top kg. 272  x9

90
(35" 7/16)



I tavoli devono essere posati su pavimentazione rigide.

Posare i tavoli su tappeti o superfici deformabili ne compromette la corretta stabilità.

Sono a cura dell'installatore la movimentazione in sicurezza, le verifiche strutturali e la portata dei solai.

The tables must be set up on hard flooring.

Setting up the tables on carpets or deformable surfaces endangers their stability.

Handling in safety, structural tests and tests of the load-bearing capacity of the floor are the responsibility of the installer.



Personale consigliato per movimentare
gli articoli / Recommended staff to
handle the items 

Rimane a discrezione dell'esecutore/installatore di applicare la normativa vigente nel proprio paese per la movimentazione dei carichi

It's up to the installer to adhere to the prescriptions/regulations existing in his country for the handling of heavy goods

 AGAPECASA

via A. Pitentino, 6
46037 Governolo
Roncoferraro
Mantova - Italia

tel.+39 0376 250 311
fax.+39 0376 250 330
info@agapecasa.it
agapecasa.it

Tavoli Incas
Incas tables

design Angelo Mangiarotti, 1973

Marmo / Marble

Per superfici levigate e opache:

Si consiglia la manutenzione ordinaria di questi prodotti con il prodotto "Filarefresh", detergente protettivo. Utilizzato quotidianamente deterge le superfici e rafforza il trattamento protettivo antimacchia.

Prodotto neutro ideale anche per le superfici in pietra naturale più delicate. (Facile da usare, pronto all'uso, non necessita di risciacquo, rapida asciugatura, profumazione gradevole e certificato per il contatto alimentare).

Applicazione: Spruzzare Filarefresh sulla superficie e passare con un panno morbido e asciutto, massaggiare la superficie fino a completa asciugatura. Non risciacquare.

Per superfici lucide:

La manutenzione ordinaria di questi prodotti va fatta con detersivi neutri, intervallando l'utilizzo di "Formula marmo", crema polish per marmo di Fila. Questo prodotto, pronto all'uso, protegge e pulisce le piccole superfici in marmo, rimuove i residui calcarei lasciati dall'acqua e restituisce brillantezza alle superfici lucide consumate.

Applicazione: Agitare prima dell'uso. Versare su un panno e passare sulla superficie da pulire. Insistere per pochi secondi fino alla completa asciugatura.



Tutti i prodotti Agapecasa sono progettati e realizzati per uso interno. Non possono essere collocati all'esterno se non diversamente indicato.

I tavoli in pietra Serena possono essere utilizzati anche all'esterno.

For smooth and opaque surfaces:

We recommend routine maintenance of these products with the product "Filarefresh" protective detergent. For daily use, it cleans the surfaces and strengthens stain-resistant treatment.

It's a neutral product also ideal for delicate natural stone surfaces. (Easy to use, ready to use, no rinse, quick drying, pleasing scent and certified for food contact).

Application: Spray Filarefresh on the surface and pass with a soft, dry cloth, massage the surface until completely dry. Do not rinse.

For shiny surfaces:

Ordinary maintenance of these products has to be done with neutral detergents, employing every now and then "Marble Formula", a polish cream for marble by Fila. This product, ready to use, protects and cleans the small marble surfaces, removes the limestone residues left by the water and gives back shining effect to the marble surfaces.

Application: Shake before using. Pour on a cloth and pass on the surface to be cleaned. Insist for a few seconds until fully dry.

All Agapecasa products are designed and manufactured for internal use. They cannot be placed outside unless otherwise indicated.

The tables made from Extraforte are also suitable for outdoor use.

Istruzioni di Montaggio

Assembly Instructions.

p. 3/7

Tavoli Incas
Incas tables

design Angelo Mangiarotti, 1973

Contenuto della confezione
Package Contents

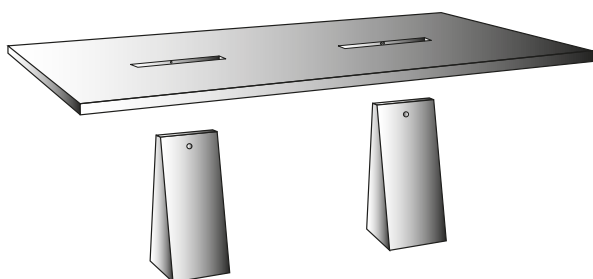

Feltri
Felt

Strumenti necessari
Required Tools

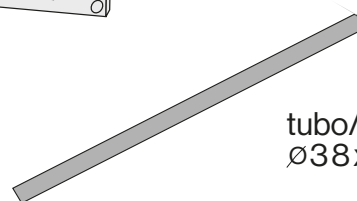
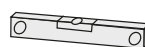

tubo/tube
Ø38x1200 mm

0. Per applicare i feltri adesivi vedi pagina 6 e 7
To apply the felt adhesives see page 6 and 7

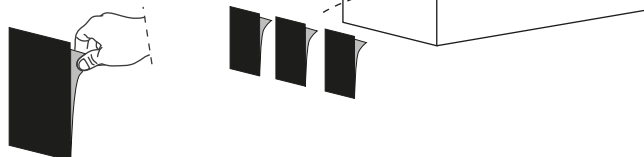

1. Posizionamento dei sostegni
Placement of the legs

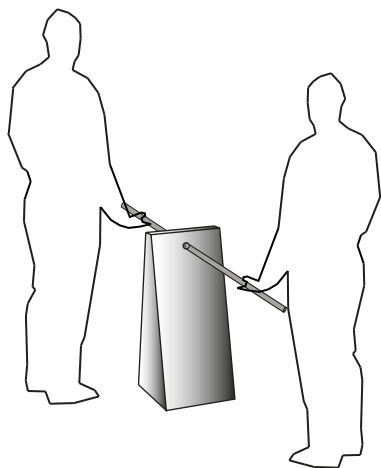

2. Misure per il posizionamento (mm)
Measurements for placement (mm)

Codice Code	Dim. tavolo Table size	X
AINC90240722	240 x 90	1110
AINC90280722	280 x 90	1310

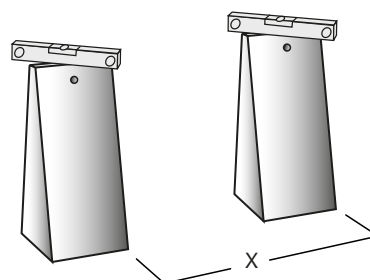

AGAPECASA

via A. Pitentino, 6
46037 Governolo
Roncoferraro
Mantova - Italia

tel.+39 0376 250 311
fax.+39 0376 250 330
info@agapecasa.it
agapecasa.it

3.



Attenzione! Ogni sostegno ha il suo riferimento corrispondente alla sede del piano.

Attention! Each support has their reference, corresponding to the seat of the top.

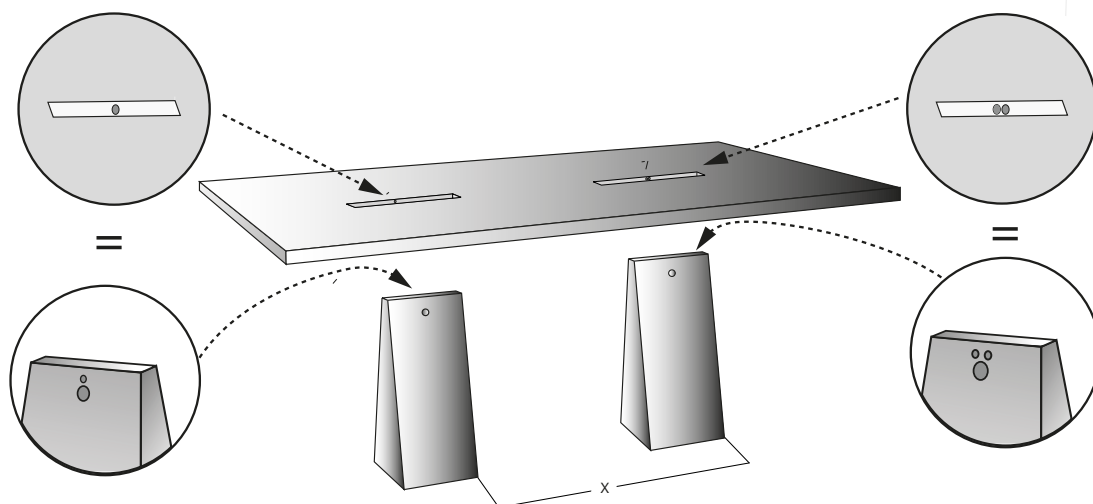

4.

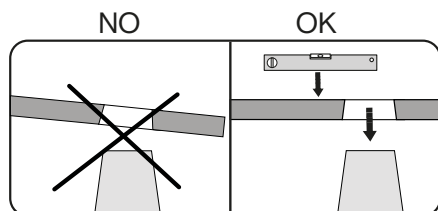

Lentamente.

Slowly

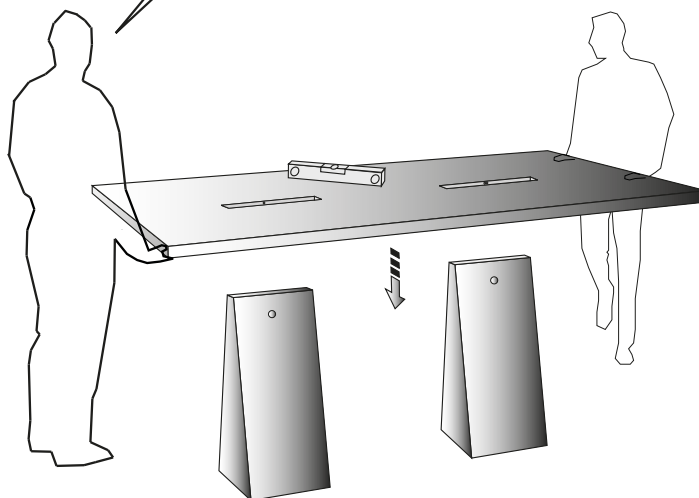

Il numero di persone raffigurate nell'immagine sono solo a scopo rappresentativo, vedere pag. 1 per il numero di persone consigliato

The number of people depicted in the image are for representative purposes only, see page 1 for the recommended number of people.

Guida movimentazione dopo installazione

Movement guide after installation



I tavoli assemblati devono essere smontati se necessario movimentarli dopo l'installazione.

Tables have to be dismantled if necessary to move them after installation.

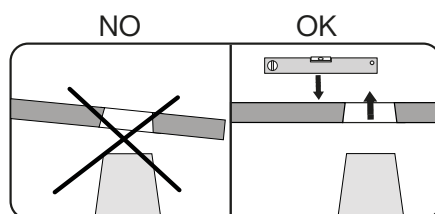
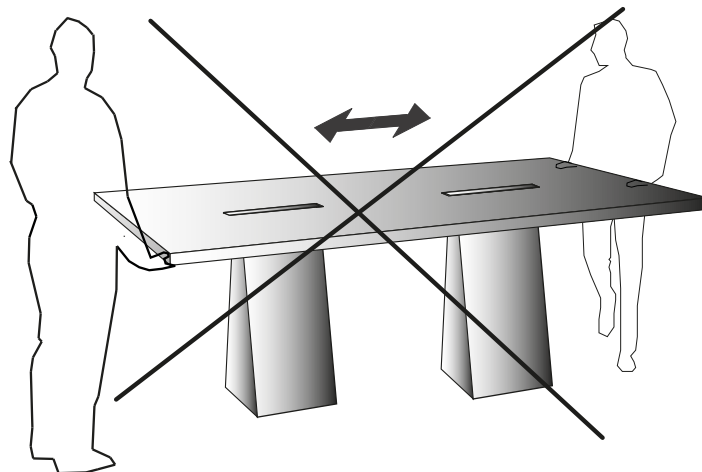

In caso di smontaggio procedere sollevando il piano mantenendolo il più parallelo possibile

In case of disassembly proceed lifting the top keeping it as parallel as possible

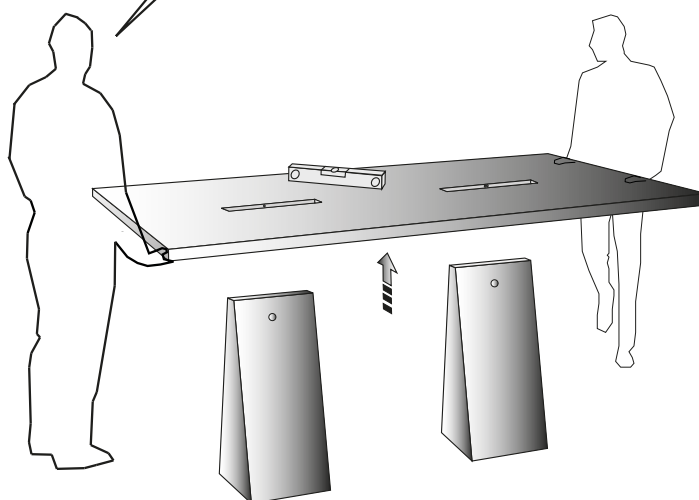

Il numero di persone raffigurate nell'immagine sono solo a scopo rappresentativo, vedere pag. 1 per il numero di persone consigliato

The number of people depicted in the image are for representative purposes only, see page 1 for the recommended number of people.

Istruzioni di Montaggio

Assembly Instructions.

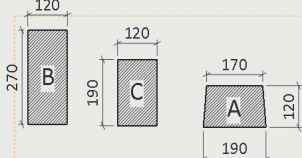
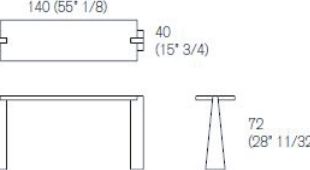
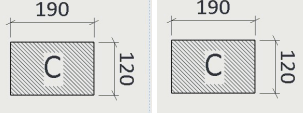
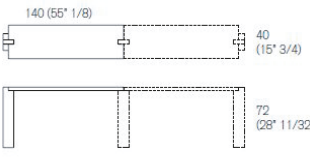
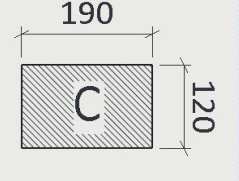
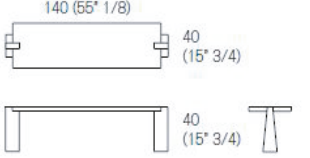
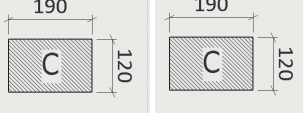
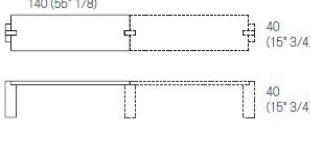
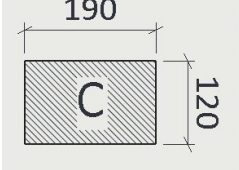
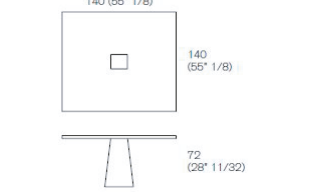
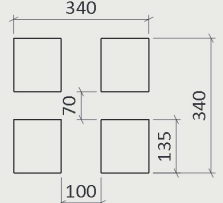
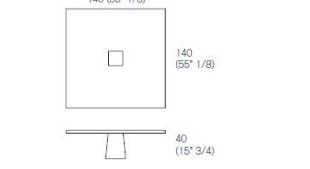
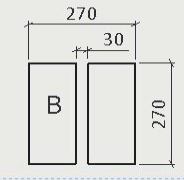
<table border="1"> <tr><td>CODICE</td></tr> <tr><td>A: PLA0739</td></tr> <tr><td>B: PLA0728</td></tr> <tr><td>C: PLA0729</td></tr> </table> 	CODICE	A: PLA0739	B: PLA0728	C: PLA0729	COD. TAVOLO COD. TABLE	COD. FELTRO COD. FELT	POSIZIONE POSITION	QUANTITA' QUANTITY
CODICE								
A: PLA0739								
B: PLA0728								
C: PLA0729								
	AINC	4014072	.PLA0729	 <p>2</p>				
	AINC	4014072M	.PLA0729	 <p>1</p>				
	AINC	4014040	.PLA0729	 <p>2</p>				
	AINC	4014040M	.PLA0729	 <p>1</p>				
	AINC	14014072	.PLA0728	 <p>2 Ricavati dal tipo B</p>				
				 <p>2</p>				

Istruzioni di Montaggio

Assembly Instructions.

	AINC	9022072	.MOBINCE72	.PLA0729		5
	AINC	90240722	.MOBINCD72	.PLA0729		6
	AINC	90280722	.MOBINCD72	.PLA0729		6
	AINC	9022072	.LEGINCF72	.PLA0728		5
	AINC	90240722	.LEGINCG72	.PLA0728		6
	AINC	90300722	.LEGINCH72	.PLA0728		6
	AINC	90220724	.LEGINCE72	.PLA0739		4